

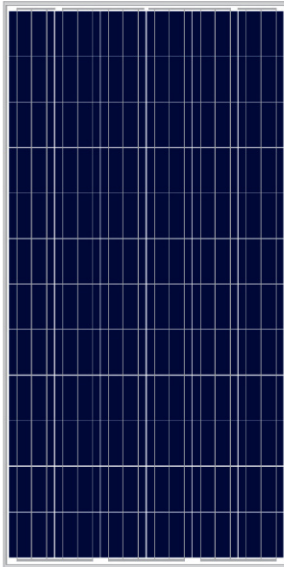





- Add Linuo Hi-tech Park, No.30766 East Jingshi Road, Jinan, Shandong, China
- Hotline 0086-531-8872-9770 / 0086-531-8872-9106
- Email pv@linuo.com



LN300(36)P-3-xxx(300-320W poly)

Key Features

-  25 year irrevocable warranty insurance-Solarsafe
-  High performance and power output in low solar irradiation
-  Anti-reflective and self-cleaning surface reduces power loss from dirt and dust
-  Certified to withstand increased snow loads of up to 5400pa and wind loads of up to 2400pa
-  High salt and ammonia resistance certified by TUV Nord
-  Top-Ranking in STS Long-term Test

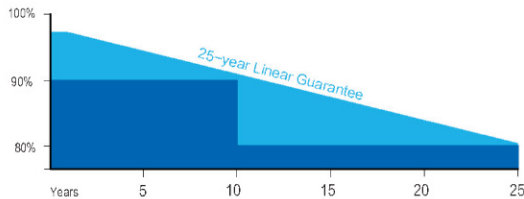

Superior Warranty



25-year Linear Power Output Warranty

In the first year of warranty, the peak power of poly-crystalline module should be no less than 97.5% of the rated power (Pmax.) and 96.5% for mono-crystalline module. At the end of the 25th year, power of modules should be at least 80% of rated power. The annual decline in performance is 0.729% maximum for poly-crystalline modules and 0.68% for mono-crystalline modules.

Reliable Quality

-  Power output: Positive tolerance of up to 5W
-  100% EL 3 times-inspection ensures modules are defect free
-  10 year product warranty, 25 year linear performance warranty

Comprehensive Certificates

- IEC61215, IEC61730, UL1703
- TUV, UL, JET, Golden Solar, J-PEC, CEC, MCS, CE
- ISO9001:2008
- ISO14001:2004
- OHSAS 18001:1999:



* Specification subject to technical changes and tests, Linuo Power reserves the right of final interpretation.



■ Engineering Drawings

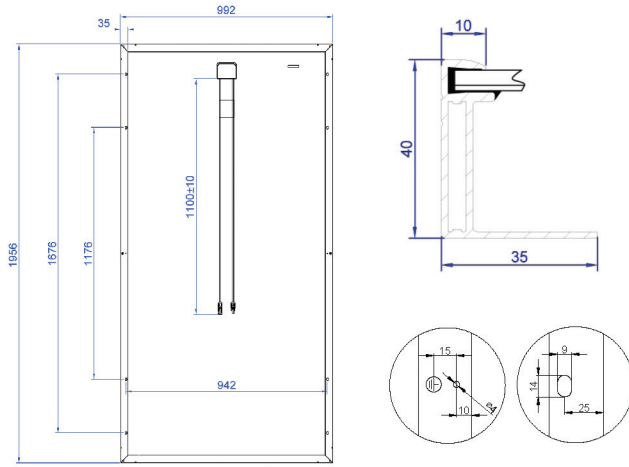

■ Temperature Coefficient

temperature cycling range	-40°C to +85°C
nominal operating cell temperature	46 ± 2 °C
temperature coefficient of Isc:	0.049%/°C
temperature coefficient of Voc	-0.322%/°C
temperature coefficient of Pmax	-0.428%/°C

■ Warranty

10 years warranty on materials workmanship and module defect.

25 years performance warranty(10 years at 90%, 25 years at 80%)

■ Electrical Parameters

Pmax (W)	Umpp (V)	Impp (A)	Uoc (V)	Isc (A)	FF	Module Efficiency	Max System Voltage	Max Series Fuse
300	36.86	8.14	44.94	8.72	76.56%	15.46%	1000V	15A
305	37.02	8.24	45.06	8.83	76.67%	15.72%	1000V	15A
310	37.26	8.32	45.18	8.92	76.92%	15.98%	1000V	15A
315	37.46	8.41	45.26	9.02	77.17%	16.23%	1000V	15A
320	37.65	8.5	45.41	9.11	77.36%	16.49%	1000V	15A

■ I-V Curve

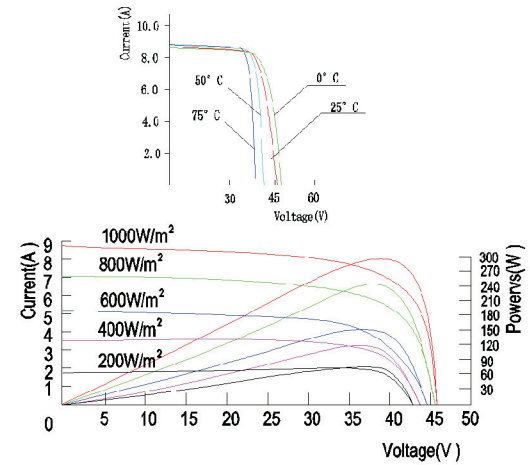

■ Mechanical Data

module dimension:	1956 × 992 × 40mm
weight:	23.5kg
mechanical load:	5400 pascals
number of cells:	72pcs
thickness of glass:	4.0mm

■ Packaging Configuration

modules per pallet:	26 pcs
modules per 40' HQ:	572 pcs

STC: Irradiance 1000W/ m²

NOCT: Irradiance 800W/ m²

Module: Temperature 25°C

Module: Temperature 20°C

AM=1.5

AM=1.5

Wind Speed 1m/s

